



# D-214-MATX

2U Compact Rackmount MicroATX Chassis



## ① Features

- ① Industrial Chassis with 15" in Depth
- ② Supports Front Access USB2.0 x 2
- ③ Power and HDD LED
- ④ Power and Reset Switch
- ⑤ Support ATX PS2 Power Supply
- ⑥ Support 4 x Low Profile Add-on Cards
- ⑦ 80mm x 2 Cooling Fan (Optional)



micro-ATX  
9.6"x9.6"



mini-ITX  
6.75"x6.75"



USB 2.0



Compact 15"  
and Under  
(Chassis)



OEM  
ODM Available

## ② Product Overview

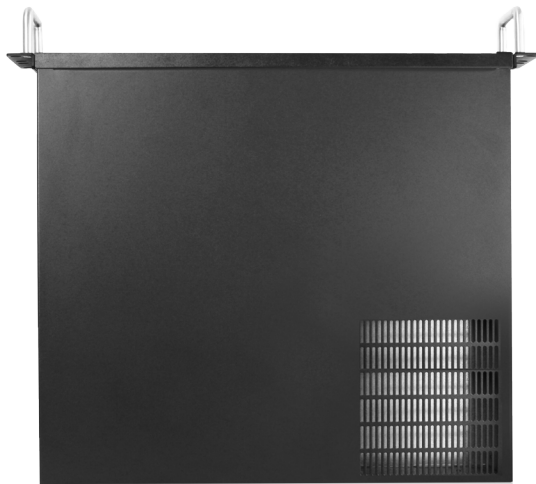

Top view

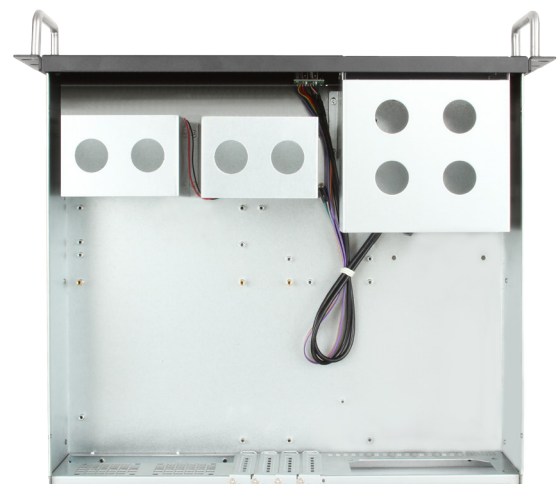

Inside view



Side view



Rear view



2x USB 2.0  
Power HDD LED Indicators  
power Reset switch



Steel handles

# D-214-MATX

2U Compact Rackmount MicroATX Chassis

## ③ Product Introduction

D-214-MATX is a reliable and stable 2U-high 15" depth industrial computer chassis. The full size I/O supports all microATX motherboard with a Dual-core/ Quad-Core processors and the backplane supports 4 low profile add-on cards. This chassis is only 15" in depth and has optional two intake 80mm cooling fans at front for air ventilation. In addition, D-214-MATX supports a standard ATX PS2 power supply to meet regular server system applications.

## ④ Specifications

Form Factor (U=1.75)	2U
Dimension	481.9 x 88.8 x 396.3 mm 19.00 x 3.50 x 15.61 inches
M/B Form Factor	Micro ATX, Mini-ITX
5.25" Ext. Bay	1+1
3.5" Ext. Bay	0
3.5" Int. Bay	2
3.5" Hot-Swap Bay	0
2.5" Hot-Swap Bay	0
2.5" Int. Driver	0
Slim FDD	0
Slim ODD	0
Expansion Slots	4(Low Profiles)
Rear Window	Standard
Security	n/a
Front I/O	2xUSB 2.0
Color of bezel	Black
Color of Hot-Swap tray	n/a
Indicator	Power on/off,HDD
Switch	Power on/off, Reset
Front Bezel	SGCC 1.2mm
Body	SGCC 1.2mm
Handle	STEEL
Air Filter	front panel washable
Standard fan	n/a
Optional Fan	2x80mm

# D-214-MATX

2U Compact Rackmount MicroATX Chassis

## 5 2D Drawing

Rackmount microATX Chassis

Low profile x 4

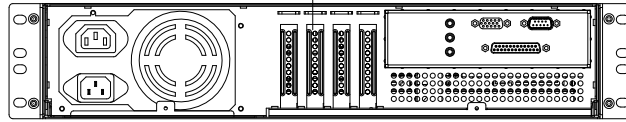

PS2 Power

9.6" x 9.6" Micro ATX

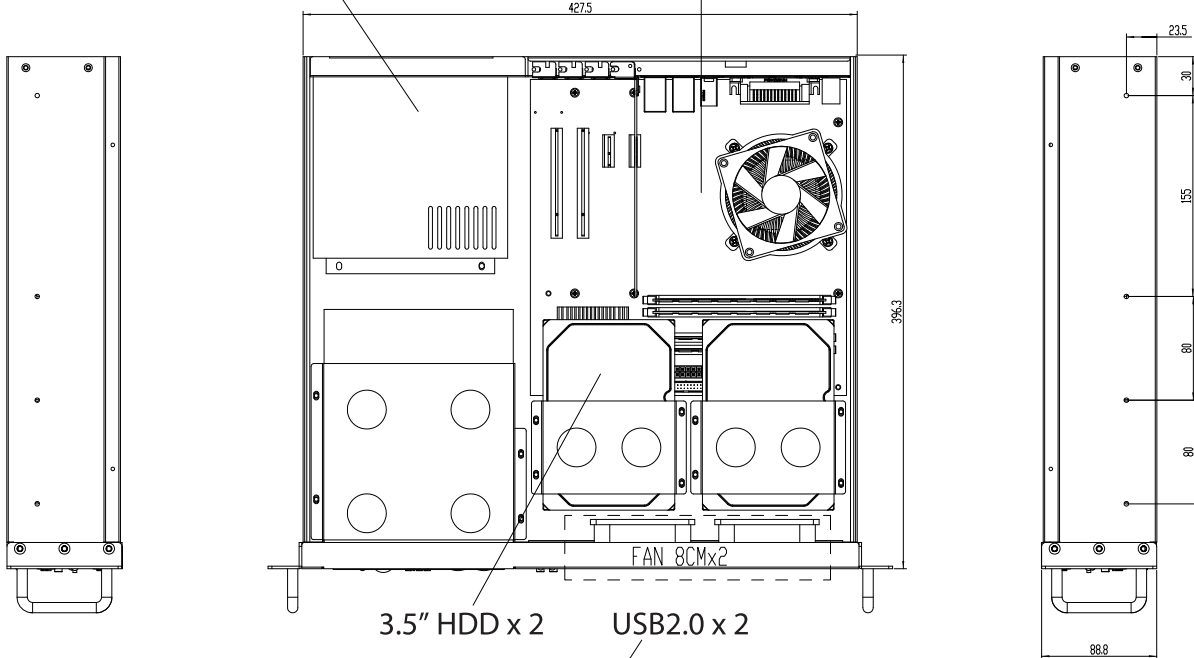

3.5" HDD x 2

USB2.0 x 2

5.25" x 2 bay

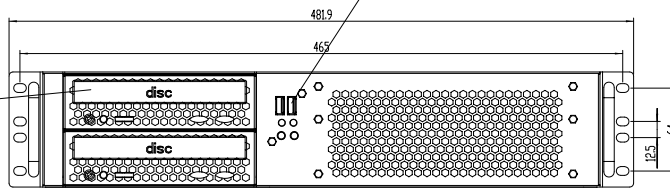

Power LED

HDD LED

8.0cm Fan x 2 (optional)

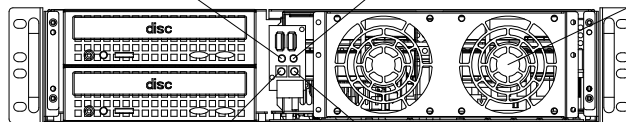

Power switch

Reset

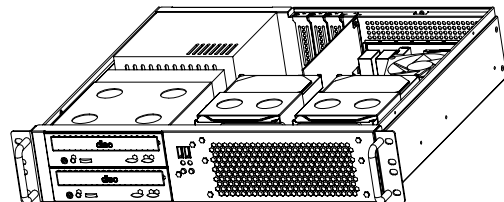
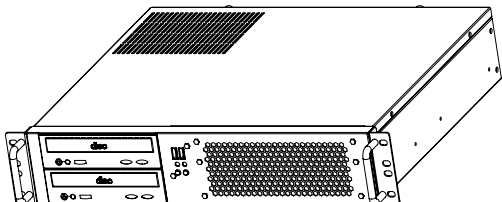

APPROVED