



D-213-MATX

2U Compact Rackmount MicroATX Chassis



① Features

- 1 Industrial Chassis with 16" in Depth
- 2 Supports Front Access USB2.0 x2
- 3 Power and HDD LED
- 4 Power and Reset Switch
- 5 Support ATX PS2 Power Supply
- 6 Support 4 x Low Profile Add-on Cards



micro-ATX
9.6"x9.6"



mini-ITX
6.75"x6.75"



USB 2.0



OEM
ODM Available

② Product Overview



Front view



Inside view



Side view



Rear view



2x USB 2.0
Power HDD LED indicators
power reset switch

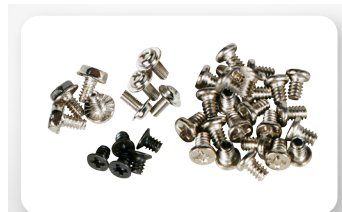

Screws

Value Rackmount

D-213-MATX

2U Compact Rackmount MicroATX Chassis

③ Product Introduction

D-213-MATX is a reliable and stable 2U-high 16" deep industrial computer chassis. The full size I/O supports all microATX motherboard with a Dual-core/ Quad-Core processors and the backplane supports 4 low profile add-on cards. This chassis is only 16" in depth and with optional two intake 80mm cooling fans at front for air ventilation. In addition, D-213-MATX supports a standard ATX PS2 power supply to meet regular server system applications.

④ Specifications

Form Factor (U=1.75)	2U
Dimension (WxHxD)	482.6 x 88.8 x 395.1 mm 19.00 x 3.50 x 15.55 inches
M/B Form Factor	Micro ATX, Mini-ITX
5.25" Ext. Bay	1
3.5" Ext. Bay	0
3.5" Int. Bay	2
3.5" Hot-Swap Bay	0
2.5" Hot-Swap Bay	0
2.5" Int. Driver	0
Slim FDD	0
Slim ODD	0
Expansion Slots	4 (Low Profiles)
Rear Window	2U
Security	n/a
Front I/O	2xUSB 2.0
Color of bezel	Black
Color of Hot-Swap tray	n/a
Indicator	Power on/off,HDD
Switch	Power on/off, Reset
Front Bezel	Aluminum
Body	SGCC 1.2mm
Handle	Aluminum
Air Filter	n/a
Standard fan	0
Optional Fan	2x80mm

D-213-MATX

2U Compact Rackmount MicroATX Chassis

Value Rackmount

5 2D Drawing

Low profile x 4

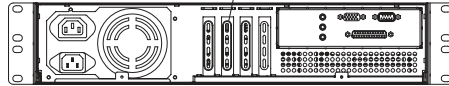

PS2 Power

9.6" x 9.6" Micro ATX

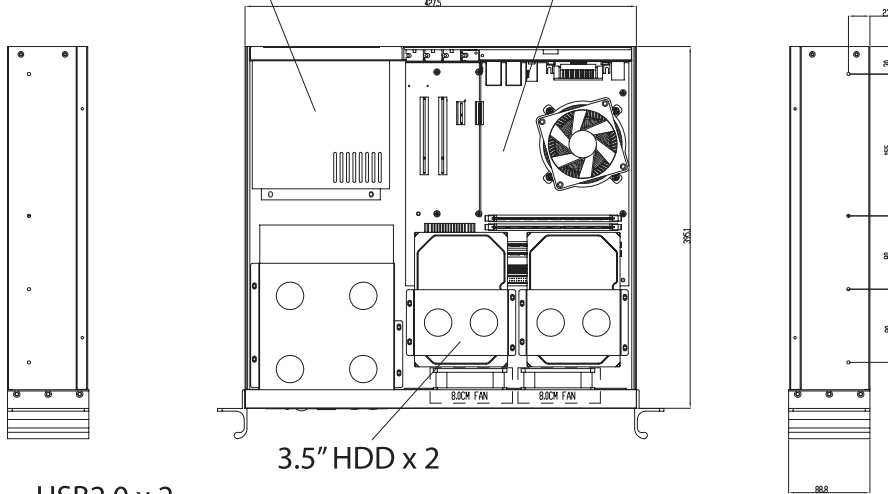

3.5" HDD x 2

USB2.0 x 2

5.25" x 1 bay

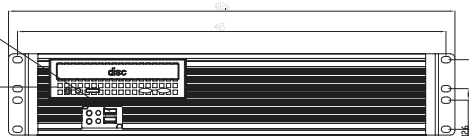

Power LED

Power switch

Reset

HDD LED

8.0cm Fan x 2 (optional)

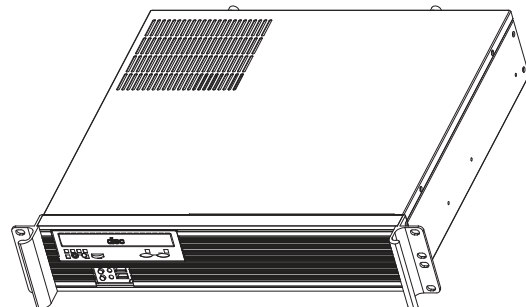
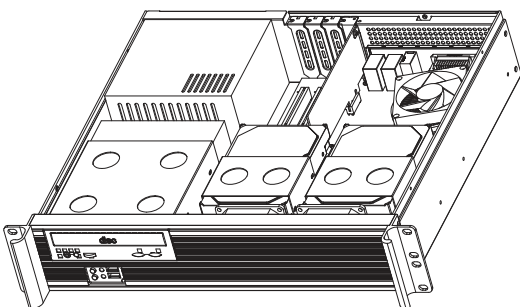
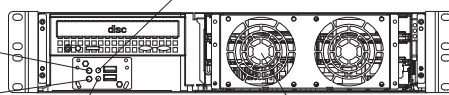

比例 1:2

APPROVED